

Spherical roller bearings, cylindrical and tapered bore

Principal dimensions			Basic load ratings		Speed ratings	Limiting speed	Designation
d	D	B	dynamic C	static C0	Reference speed		* SKF Explorer bearing
mm			kN		r/min		-
<b>460</b>	760	240	6760	10800	430	800	23192 CAK/W33 *

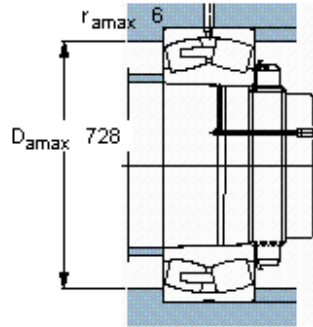
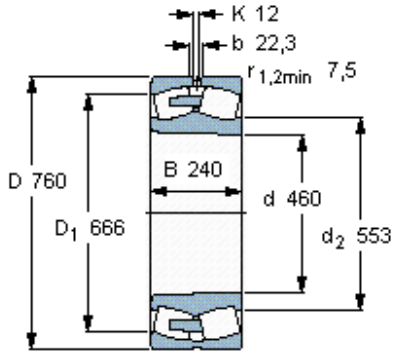

Tapered bore, taper  
1: 12

**Calculation factors**

- e 0,3
- $Y_1$  2,3
- $Y_2$  3,4
- $Y_0$  2,2